



CF1S-FS(L)

Commercial Series Freezers



CF1S-FS(L)
01/08/18
Item # 13363

W x D x H
27.5" x 34" x 79.5"*
*4" casters

CF1S-FS



CF1S-FSL



Dimensions / Capacity

	One Section CF1S-FS(L)
Interior Storage Capacity (CF)	22.8 ft ³
Interior Storage Capacity (CF) (AHAM)	20.9 ft ³
Overall Width x Depth	27.5" x 34"
Height (including 4" casters)	79.5"
Door Opening Width x Height	22 x 59.25"
Depth with Door Open at 90°	59.75"
Adjustable Shelves	3
Shelf Dimensions (W x D)	21.25" x 26"
Crated Shipping Weight	360 lbs
Crated Height x Width x Depth	83" x 31.5" x 39.5"

Electrical / Refrigeration

	One Section CF1S-FS(L)
Voltage	115/60/1
HACR Breaker	15.0 Amps
Electrical Connection (NEMA)	5-15P ⓘ
Voltage Range	104-126
Ambient Temp. Range	45° to 100°F
Control Setpoint Range	-10° to +12°F
Amperage	9
Energy Consumption (kWh/day) @ASHRAE	5.38
Heat Rejection (BTU/Hr.) @NSF	1429
Approx. Nominal Compress. BTU/HR (HP)	2466 (1/2HP)
Refrigerant / Charge Amount (oz)	R-404A / (7.5 oz)

Options

- Door reversal kit
- Foot pedal door opener
- Additional epoxy shelves
- Air filter
- Stainless steel shelves
- Tray/Pan slides

Warranty

- * 3 Year - parts and Labor on entire machine.
 - 5 Year - Parts on Compressor
- Valid in United States, Canada, Puerto Rico and U.S. Territories. Contact factory for warranty in other countries.

Item #: _____

Project: _____

Qty: _____

AIA#: _____

Features

- ▶ **Stainless steel interior with stainless steel exterior front and sides**
- ▶ **Refrigerant flow is controlled with thermostatic expansion valve**
- ▶ **Unique "ducted" air distribution system**
- Solid state digital controller with temperature alarms and LED display (Fahrenheit or Celsius)
- Cabinet and doors are insulated with 2-3/8" of CFC free, foamed in place polyurethane
- Stainless steel exterior and interior door come standard with locks
- Exclusive stepped door design to protect recessed door gasket
- Spring assisted self-closing doors with stay open feature
- Sturdy 8 gauge stainless steel hinge plate with welded hinge pin
- Extruded aluminum flush mount door handle
- Field reversible doors (with optional kit)
- Evaporator coils are epoxy electrocoated (E-Coat) to help fight corrosion
- Energy efficient automatic hot gas condensate evaporator
- Stainless steel shelf supports
- (3) epoxy coated wire shelves are standard
- Standard with 4" casters (two with brakes)
- Stackable (two units high) to conserve warehouse floor space
- Three years parts and labor warranty
- Five year compressor warranty
- 8 ft. cord and plug



CF1S-FS(L)

Commercial Series Freezers

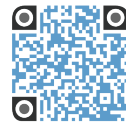

CF1S-FS(L)
01/08/18
Item # 13363

FRONT VIEW

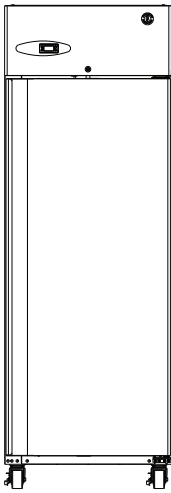

CF1S-FS

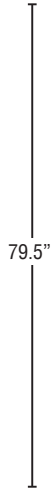

CF1S-FSL

SIDE VIEW

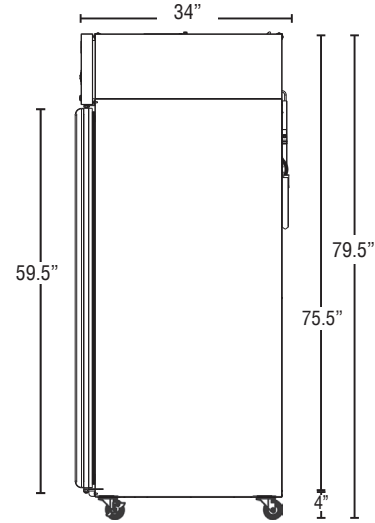

CF1S-FS(L)

PLAN VIEW

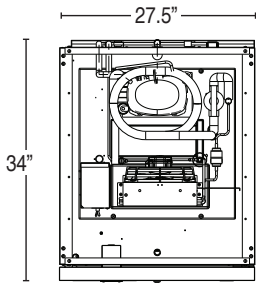

CF1S-FS(L)

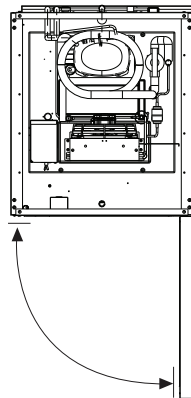

CF1S-FS
(Showing Right Swing)

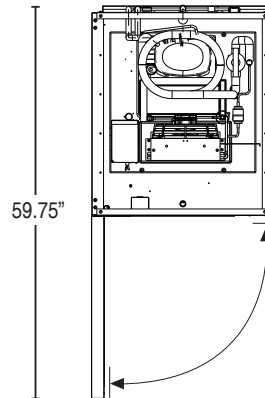

CF1S-FSL
(Showing Left Swing)

Cabinet Construction

The exterior cabinet front, and sides, are constructed of high quality stainless steel. The exterior top, back, and bottom are constructed of coated steel. The cabinet interior is constructed of stainless steel with a unique "ducted" air flow system. Three (3) heavy duty epoxy coated shelves per section are standard. Mounted on stainless steel pilasters shelves are adjustable in 1" increments. Cabinet walls and doors are insulated with 2-3/8" of environmentally friendly, CFC free, foamed in place polyurethane. Perimeter door heaters prevent condensation from forming on the face of the cabinet. An interior light is automatically activated when doors are opened. 4" polyolefin, casters (two with brakes) are standard.

Door Construction

Doors are constructed of a high grade stainless steel exterior and interior and are standard with locks. Hoshizaki's exclusive "stepped" design protects the recessed gasket while product is being removed from the cabinet. Doors are provided with a one piece, full length extruded aluminum flush mount handle and are mounted on eight (8) gauge stainless steel hinge plates with a welded hinge pin. Spring assisted self-closing doors are equipped with a stay open feature past 90 degrees. Snap-in magnetic door gaskets are easily removed for cleaning. Door hinging is field reversible (with an optional door reversal hinge kit).

Refrigeration System

The high efficiency refrigeration system is self-contained with an epoxy electrocoated (E-Coat) evaporator for extended life. Top mounted refrigeration system is easily accessible for service. The refrigeration system components are assembled on a high density expanded polypropylene platform that is removable from the main unit. A unique ducted air flow system achieves uniform air distribution within the cabinet to eliminate hot spots. Condensate removal is accomplished with an energy efficient non-electric evaporation system. A thermostatic expansion valve (TXV) controls the flow of environmentally friendly R-404A refrigerant through the evaporator. Refrigeration system utilizes a heated defrost to eliminate any ice on the evaporator coil. Solid state digital controls monitor the operation and performance of the refrigeration system. The controls also provide visual high and low temperature and high and low voltage alarms. A LED display shows the cabinet temperature and is adjustable to Fahrenheit or Celsius. 115 volt units are equipped with an eight foot cord and plug (20.0 amps or less).

Printed in the U.S.A.